

High-efficiency
gas/liquid contacting.



The best media for gas/liquid contacting.

Mott porous metal. There's no better media for producing miniature, slow-moving bubbles – the best method of achieving high-efficiency gas/liquid contacting. For decades, Mott porous metal spargers have been the fast, reliable, cost-effective choice for gas/liquid contacting in all sorts of industries. Here are a few reasons why:

Small bubbles transfer gases faster, more efficiently.

Mott spargers introduce gases into liquids through thousands of tiny pores, creating bubbles far smaller and more numerous than with drilled pipe and other sparging methods. The result is greater gas/liquid contact area, which reduces the time and volume required to dissolve gas into liquid.

With thousands of pores over the surface, large volumes of gas can be passed with very high specific area. For example, with equal volumes of gas, 1mm bubbles would have 6.35 times more gas/liquid contact surface area than 6.35mm (1/4") bubbles.

All-metal construction lasts for years.

Mott spargers are constructed entirely of metal, to provide long-lasting operation even in the midst of temperatures as high as 1450°F under oxidizing conditions. And for inert and corrosive media, Mott offers a wide range of materials including 316L stainless steel (standard), Nickel 200, Monel® 400, Inconel® 600, Hastelloy® C-22/C-276/X and Alloy 20.

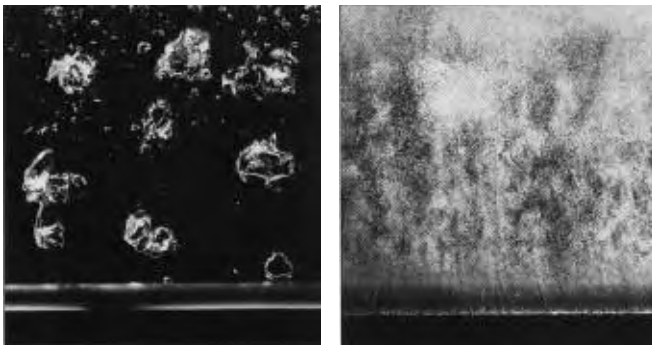

Conventional drilled pipe spargers (left) produce poorly dispersed, large, fast-rising bubbles with very low surface area.

Mott porous metal spargers (right) create millions of small, slowly rising bubbles, with significantly more surface area, resulting in more complete and rapid mass transfer.

Simple, cost-effective, easy-to-install.

Mott spargers typically consist of a porous metal element, a threaded fitting and, in longer units, a reinforcement rod. The design is simple, without moving parts. Installation is easy, and requires no special tools. From single elements to manifolded systems, Mott spargers are among the simplest, most affordable and most efficient gas/liquid contacting solutions available anywhere.

All sizes and configurations.

Mott spargers are designed, manufactured and finished at Mott. So if you need a non-standard size, or a special fitting, Mott has the capability to accommodate your request.

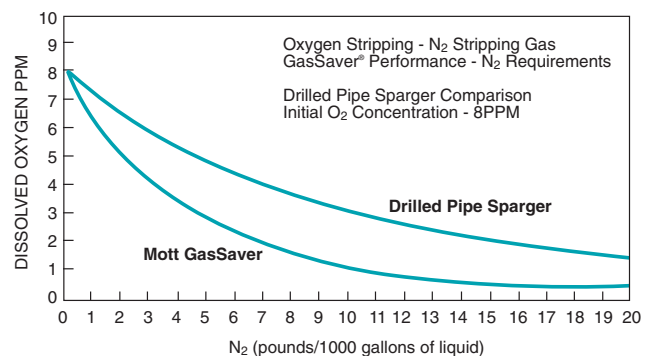

Oxygen stripping, using nitrogen. Actual performance data shows the superiority of Mott porous metal spargers, compared to drilled pipe spargers. Much higher performance levels with significantly lower gas consumption.

Static spargers.

Tank spargers.

In-tank sparging applications can be for batch or continuous operation, with or without agitation within the vessel. Mott sparging technology provides performance-proven designs to assure optimum process operation.

Mott spargers are arranged in the bottoms of tanks and vessels in a variety of ways. For smaller tanks, one sparger will often suffice. For larger tanks, several Mott spargers may be manifolded together using a linear or radial pattern to achieve optimal gas diffusion.

Mott offers a wide variety of standard tank sparger elements and manifolded assemblies to accommodate most applications. Custom designs are also available by request.

Typical tank sparger arrangements

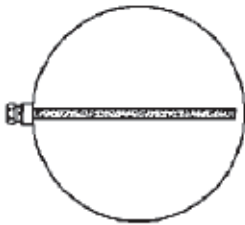

Single Element
Type 6400 Element
Side Mounted

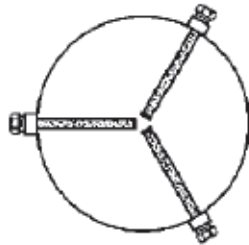

Multiple Elements
Type 6400 Elements
Side Mounted



Single Element
Type CD Element
Dip Leg Mounted

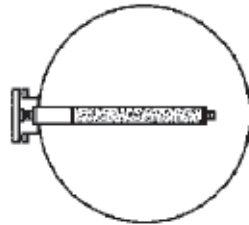

Single Element
Type CD Element
Flanged Side Mounted



Manifolded (Cross)
Type A Elements
Dip Leg Mounted



Cross Tank
Type A Elements
Flanged Side Mounted

Sparger elements.

Type A

Hex Nipple
From 0.375" up to 2.5" diameter

Type CD

Reinforced 1.5", 2" and 2.5" diameter

Type G

Plain Tube
From 0.375" up to 2.5" diameter

Type 6400

Reducer Mounted
From 0.375" up to 1" diameter

Type 850

Reducer Mounted
Impingement Tube
From 0.375" up to 1" diameter

Type R

Trapped Flange Mounted
From 0.375" up to 2.5" diameter

Type RF

Full Flange Mounted
From 0.375" up to 2.5" diameter

Type RS

Sanitary Flange Mounted
From 0.375" up to 2.5" diameter

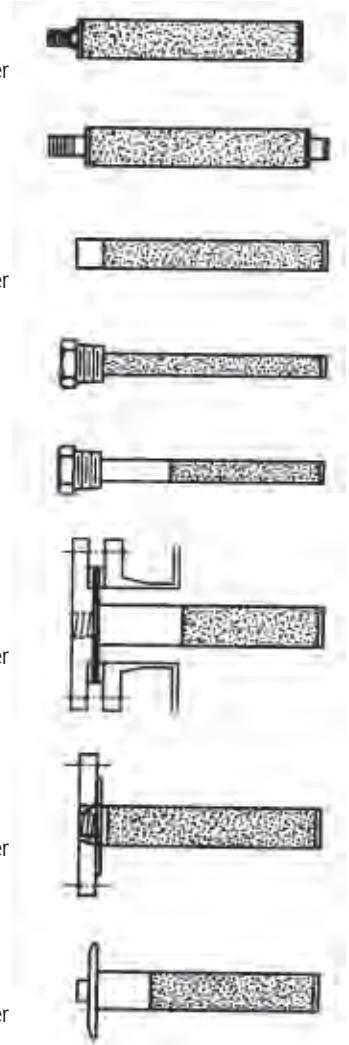

Elements larger than 2.5" diameter are available on special order.

Support Studs or Centering Rods on the closed end of elements available if required.

Reinforced elements are recommended for agitated vessels.

Standard materials are 316L stainless steel porous media with 316 stainless steel hardware. Other materials are available on special order.

Dynamic pipeline spargers.

Non-intrusive (in-line) sparging.

Mott GasSavers® are unique, high-efficiency gas/liquid contacting devices for in-line mounting in process systems. As liquid moves through the inside of a porous metal tube, gas is introduced into the annulus – the

area between the porous tube wall and the outer GasSaver housing. The gas moves through the porous metal into the liquid, creating bubbles which are quickly sheared. This action results in very fine bubbles, ideal for gas introduction as well as absorption.

Mott Laboratory GasSavers All Welded Construction

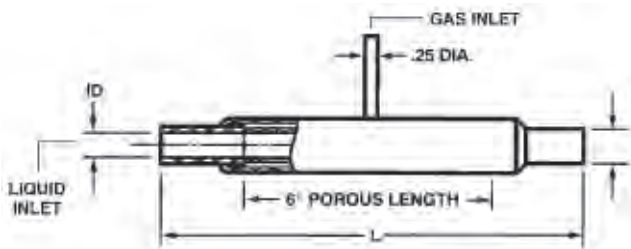

All Welded GasSaver®



Mott Industrial GasSavers

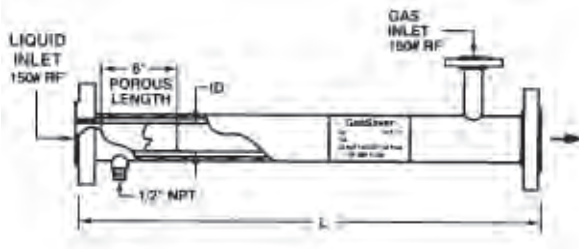

Industrial GasSaver®



Mott Sanitary GasSavers

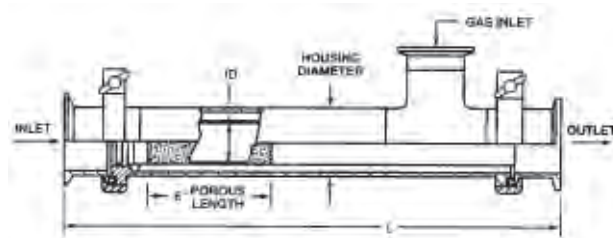

Sanitary GasSaver®



Side stream sparging.

In large installations where access to the main pipeline is difficult, a "side stream" GasSaver installation often proves to be the best configuration for optimum process performance. Units can be valved to allow maintenance without interfering with the main pipeline.

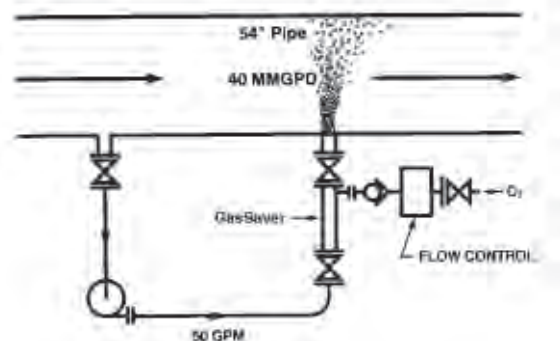

Intrusive (tangential) sparging.

A sparging element located in a pipeline constitutes an intrusive sparger. The element can be mounted in an elbow or tee in the pipeline. Liquid passes through the annulus between the pipeline and the element. Gas exits from the outside of the element where bubbles are sheared by the liquid, resulting in fine bubbles for superior performance.

Intrusive Pipeline Spargers

Series 8501

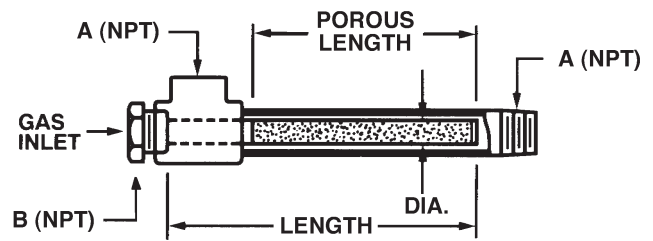

Pipe Mounted Intrusive Sparger Elements

Elbow Mounted

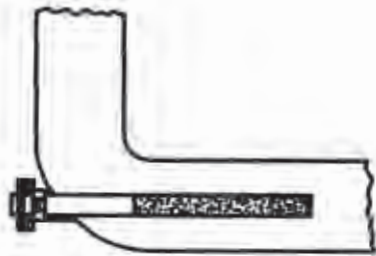

Side Mounted

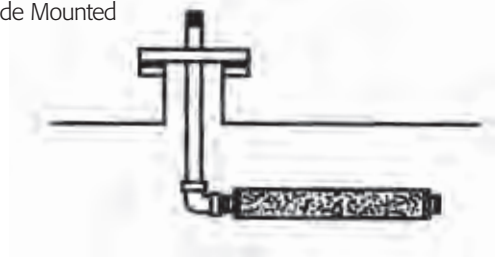

Tee Mounted

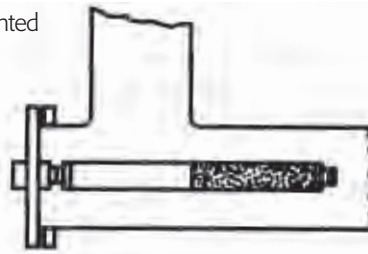

Side Angle Mounted

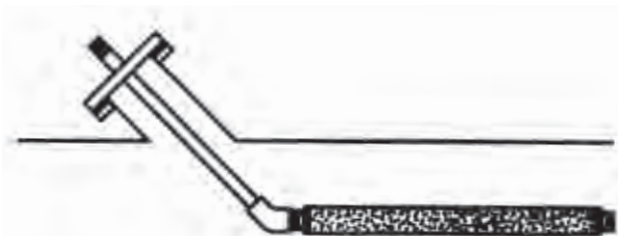

Sanitary Tee Mounted

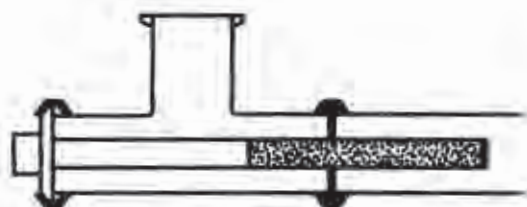

Typical applications.

Aeration – Air sparging to meet BOD (Biological Oxygen Demand) on waste stream.

Agitation – Air injection for mixing liquids in a vessel.

Bioremediation – Air sparging to stimulate growth of bacteria for hazardous waste treatment.

Carbonation – CO₂ sparging for carbonated beverages and beer.

Chlorine bleaching – Chlorine sparging for bleaching pulp in manufacture of paper.

Column flotation – Air sparging for coal flotation, and other separations of solids.

Dewatering – Nitrogen sparging to remove entrained water from motor oil.

Fermentation – Oxygen or air sparging to enhance cell growth in fermentation reactions.

Gas/liquid reactions – Sparging air, oxygen, or other gases into reactors for improved performance.

Hydrogenation – Hydrogen sparging for a broad spectrum of chemical hydrogenation reactions.

Oil flotation – Air or natural gas sparging for oil removal from produced water from oil wells.

Oxygen bleaching – Oxygen sparging for bleaching pulp in manufacture of paper.

Oxygen stripping – Nitrogen sparging to remove oxygen from edible oils, wine, and juices.

Oxygenation – Oxygen sparging in fish farming for significant stimulation of fish growth.

Ozonation – Ozone sparging to sanitize ultrapure water systems in pharmaceutical plants.

pH control – CO₂ or NH₃ sparging to adjust pH in waste or process streams.

Steam injection – Direct steam injection for efficient heating, and to eliminate “steam hammer”

Volatiles stripping – Air sparging for removal of VOC (Volatile Organic Compounds) from waste streams.

Call for a recommendation and a quote.

Let Mott identify the right sparger for you, so you can compare performance and cost to what you're using now. Just tell us the answers to these basic questions:

1. Application
2. Type of containment (tank or pipeline)
3. Gas information
 - a. Type
 - b. Flow rate (ft³/min for all gases; lbs/hr for steam)
4. Liquid information
 - a. Type
 - b. Temperature

Industries served by Mott sparger products.

- Food and beverage
- Pharmaceutical
- Chemical
- Industrial
- Pulp and paper
- Petrochemical
- Power
- Waste treatment



Established in 1959, Mott Corporation coordinates engineering, sales, service and manufacturing from two adjacent facilities totalling 90,000 square feet. Mott's skilled workforce, along with strategically located overseas affiliates, services thousands of customers all over the world, in virtually every major segment of industry.

Need a product? Need advice?

Call us either way. Whether you need a stock solution, a customized design, or simply guidance, we welcome your call. Contact the experts at Mott Corporation today.

mott corporation

84 Spring Lane, Farmington, CT 06032-3159
www.mottcorp.com, email: quest@mottcorp.com
860-747-6333 Fax 860-747-6739



ISO 9001:2008 CERTIFIED

PMSPARG Rev 1 10/08 5C