

CUSTOMER INNOVATION CENTER

mott
MISSION CRITICAL PRECISION



RAPID PROTOTYPING

- » Turnaround prototypes at 2X the speed of the competition
- » Prototype in a wide variety of alloys, shapes, hardware connections, and sizes
- » Use Mott's proprietary 3D printing technology to create unique and complex geometries for filtration and flow control applications

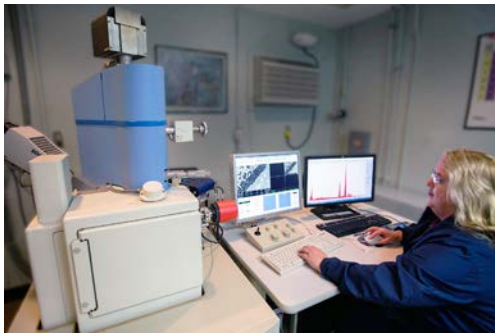
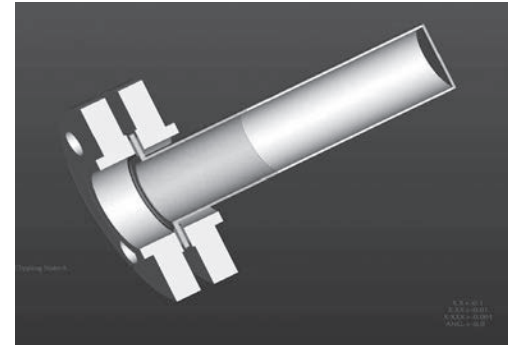

SEM/EDS ANALYSIS

- » Provides high resolution imaging of samples and elemental detection of inclusions, debris, stains, and contaminants
- » Useful for various analyses of media, identifying areas for improvements, and avoiding potential failure or downtime
- » Tests conform to ASTM E1508

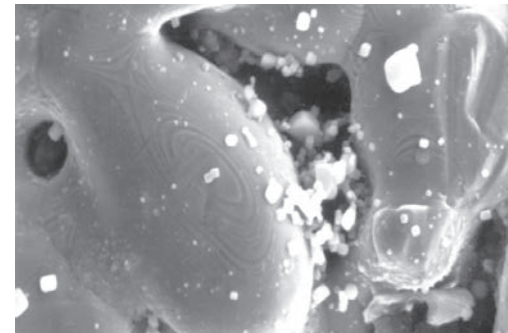

CLEANLINESS TESTING

- » Component flushing and rinsing and gravimetric testing
- » Various microscopic inspection tests available, such as optical particle counting and sizing using Hirox 3D Microscope
- » Tests conform to ASTM D5907

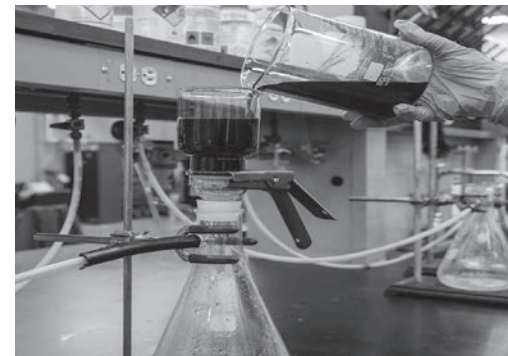

QUANTITATIVE CHEMICAL ANALYSIS

- » Optical Emission Spectroscopy and Wavelength Dispersive X-Ray Fluorescence are capable of bulk, minor, and trace elemental analysis of materials and alloys
- » Determine elemental composition of solids or liquids
- » Tests conform to ASTM E227, E415, E1086, E1251, A751, E1009, E322, E572, E1085, E1031 and E1019



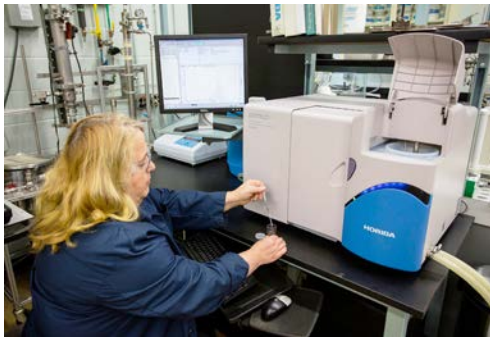

FILTRATION PERFORMANCE AND FEASIBILITY TESTING

- » Measure clean flow rate vs pressure drop, turbidity, particle size analysis, gravimetric analysis, and evaluation of cake properties
- » Testing is critical for confirming media selection and preliminary filter sizing
- » Tests conform to ASTM F795

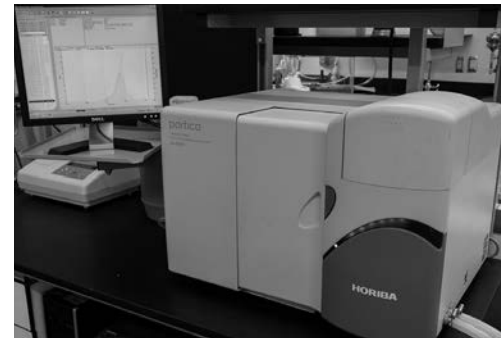

MECHANICAL PROPERTIES TESTING

- » Perform tensile, compression, and three-point bend testing on materials. Additionally, macro and micro hardness testing is available
- » Determine ultimate yield strength, ultimate tensile strength, elongation, and hardness
- » Tests conform to ASTM E8/E8M, E18, E384 and B578

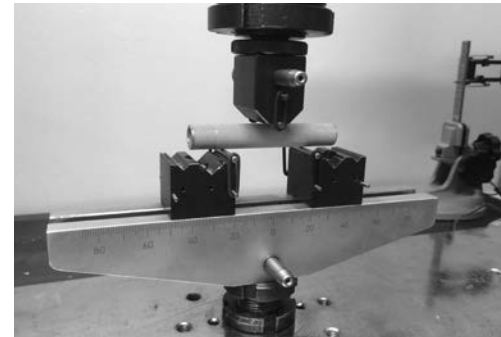

POROUS MEDIA CHARACTERIZATION

- » Measure bubble point, max pore size, pore size distribution, and flow characteristics
- » Determine design considerations for a product in order to meet your desired system specifications
- » Tests conform to ASTM E128, F316, and ISO 4003-1977

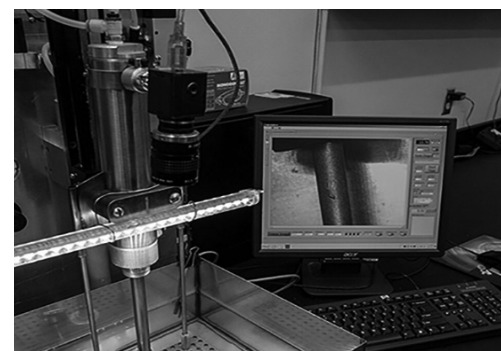

FAILURE ANALYSIS AND LIFECYCLE TESTING

- » Lifecycle testing on porous sheets is capable of measuring the effects of long term corrosion exposure, pressure cycling, and other processes that may alter mechanical integrity
- » Critical to determining when parts will likely need replacement and avoiding production downtime due to unforeseen complications
- » Tests conform to ASTM E1508

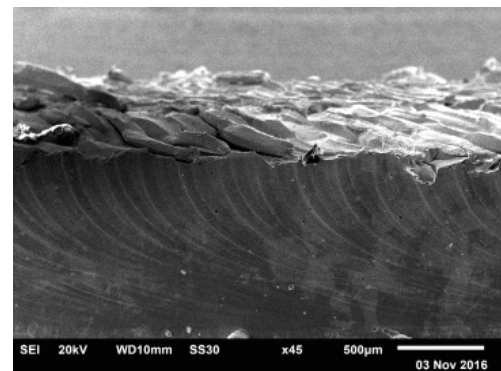

METALLOGRAPHY

- » Metallographic sample preparation, SEM/EDS, and optical microscopy techniques can determine phases in alloys, grain sizes, inclusion content, and coating thickness
- » Analyze metal media properties and characteristics
- » Tests conform to ASTM E3, E1920, E112, B487, E407, and E340

