

Precise, long-lasting  
management of  
liquids and gases.

For value-added  
instrumentation.





# High-precision, porous metal instrument filters.

Today's sensitive instruments are capable of detecting particles down to parts per trillion (ppt) levels. For the protection of critical instruments, and for processes that demand the highest purity, no filter media protects more reliably than Mott porous metal.

Unsurpassed in strength and precision, Mott media provides a long-lasting barrier against particles even when placed in harsh environments. And, with fabrication techniques proven for more than 40 years, Mott offers unique filtration features and benefits.

**Uniform porosity** – A strictly controlled manufacturing process enables Mott to produce uniformly sized and distributed pores, in media grades ranging from 0.2 to 100.

**High-efficiency particle capture** – Porous metal elements trap particles via “depth filtration,” the effect created by a labyrinth of tortuous, irregular paths leading from one side of the element to the other. This geometry traps particles far more efficiently than media containing straight channels between pores.

**No media migration** – “Solid-state diffusion bonding” holds filter media together at the molecular level, making it virtually inseparable, even under the harshest conditions. There's no risk of compromising your solution.

**High corrosion resistance** – For applications involving corrosive gases or liquids, Mott instrument filters can be constructed of special corrosion-resistant metals and alloys, such as titanium and Hastelloy®.

**High temperature tolerance** – All-metal construction, welded joint and seams, and proper material selection endure high temperatures, even in the midst of oxidizing atmospheres.

**High pressure tolerance** – Unlike “soft” media, Mott sintered porous metal can withstand differential pressures well in excess of 3000 psid because of its rigid sintered structure.

**Long life** – In most applications, Mott porous metal maintains high filtration efficiency through years of continuous use.

**Wide selection of materials** – Mott offers the industry's broadest array of metals and alloys to provide chemical compatibility for virtually any application. Standard construction is generally of 316L stainless steel, but Mott filters can also be made from a variety of metals and alloys, including Hastelloy, Inconel®, Monel®, titanium, Alloy 20, nickel and many others.

With hundreds of standard products, there's a good chance Mott already has the solution for your filtration needs. If not, Mott is more than happy to work with customers to develop solutions to fit the individual application. Working side-by-side with customers, often applying porous metal media where it's never been applied before, has led to major advancements. Mott designers and engineers customize solutions to meet new application challenges by integrating current products and components or by developing new ones.



# Series 6200 – “Tee” type filter.

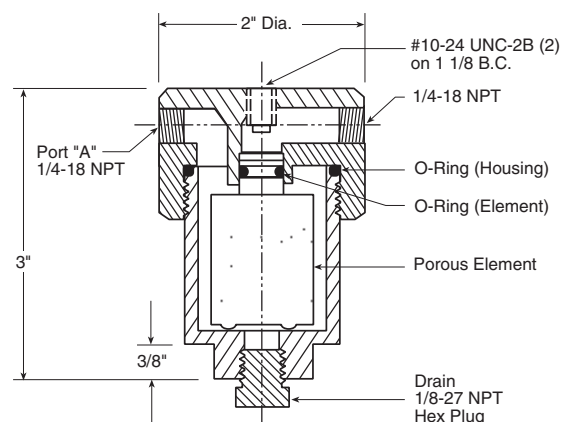

The Series 6200 filter provides the reliability of Mott precision porous metal media in a compact Tee Type filter housing, that allows easy element changeout without breaking the piping connections to the filter.

## Versatile design.

When used in traditional outside-in filtration, the head-port ("A") is used as the inlet. The filter is equally effective when used in inside-out filtration (with the unmarked head-port used as the inlet). With this configuration, contaminants are contained within the element, and are easily disposed of, eliminating the need to clean the housing. In addition, the drain can be used as a second filtrate outlet.

## Filter specifications.

Materials of construction: 316L stainless steel porous media, 316 stainless steel housing and hardware and seal material as specified.

Maximum operating pressure: 3000 psi.

Maximum differential pressure: 500 psi.

1/4" NPT inlet/outlet ports.

1/8" NPT housing drain.

Outside-in filter area: 4.8 in<sup>2</sup>.

Filter element 100% leak tested to bubble point.

## Filter options.

**Series No.** - 6204 (1/4" NPT filter)

**Seal Materials**

- B (Buna N)
- N (Neoprene)
- T (*Teflon*<sup>®</sup> encapsulated silicone)
- V (Viton)

**Media Grades** - 0.5, 2, 5, 10, 20, 40

## Spare part options.

**Elements:** Series No. 620-1 - **Select media grade**

**Housing O-rings:** Series No. 620-2 - **Select seal material**

**Spare element O-rings:** Series No. 620-3 - **Select seal material**

# Series 6200 filter assembly flow curves by media grade for 1/4" NPT.

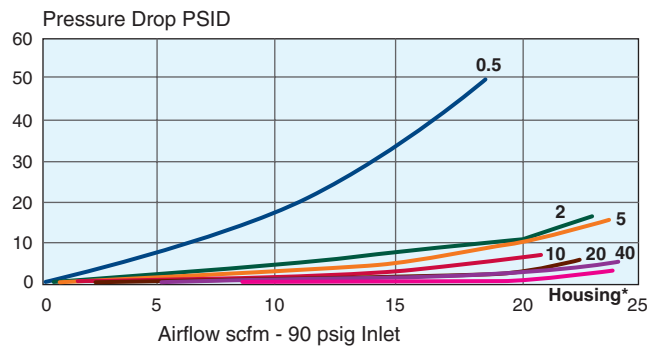
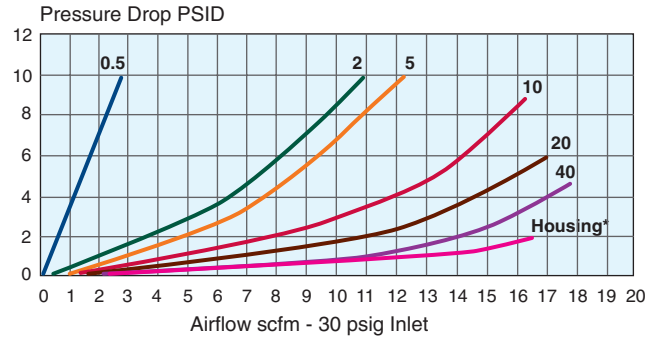
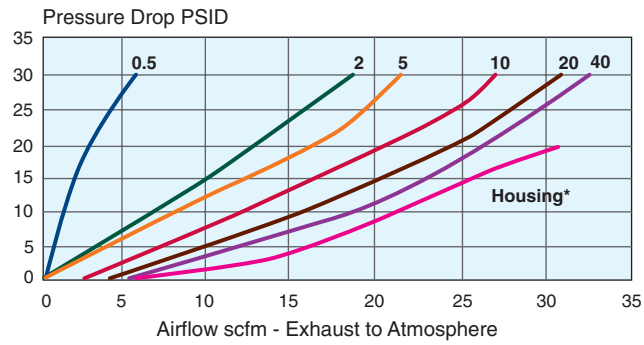
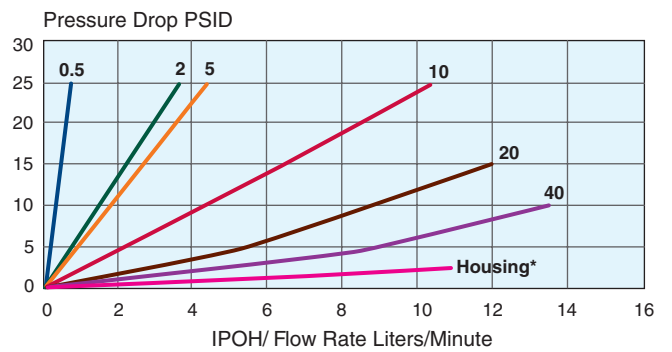
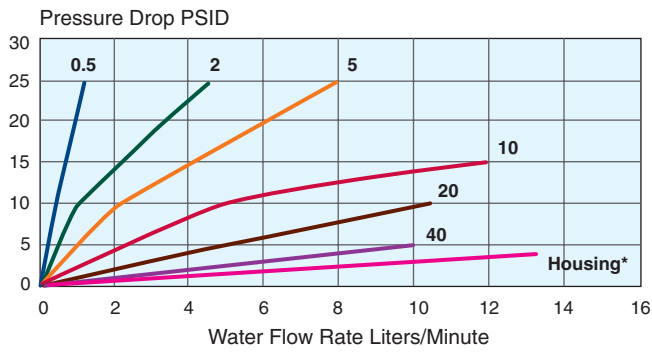

\* Housing only – no filter element installed.

# Series 6300 - "Multi-Tube" filter.

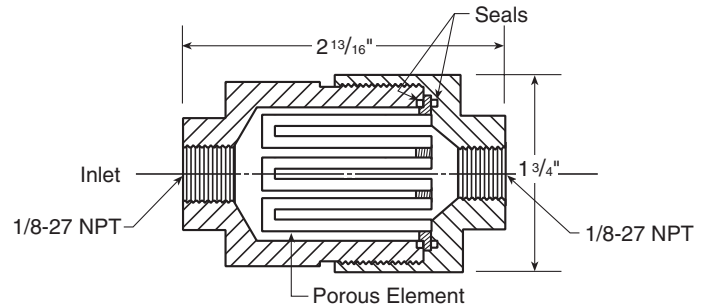

The Series 6300 filter provides the reliability of Mott precision porous metal media in a compact inline configuration. The filter element is made up of seven porous cups, which substantially increases the area over traditional designs, and increases on-stream filter life. The filter surface area is 10 square inches.

## Filter specifications.

Materials of construction: 316L stainless steel porous media, 316 stainless steel housing, seal material as specified.

Maximum operating pressure: 2000 psi.  
 Maximum differential pressure: 500 psi.  
 1/8" - 27 NPT inline inlet and outlet connections.  
 Filter area: 10 in<sup>2</sup>.  
 Filter element 100% leak tested to bubble point.

## Filter options.

- Series No.** - 6300 (Inline multi-tube filter)
- Seal Materials**
- B (Buna N)
  - N (Neoprene)
  - T (*Teflon*<sup>®</sup> encapsulated silicone)
  - V (Viton)
  - S (Stainless steel/silver plated)
  - K (Kalrez<sup>®</sup>)
- Media Grades** - 0.2, 0.5, 2, 5, 10, 20, 40, 100

## Spare part options.

- Elements:** Series No. 630-1 - **Select media grade**
- Spare Seals**  
**2 per set:** Series No. 630-2 - **Select seal material**

## Flow curves by media grade.

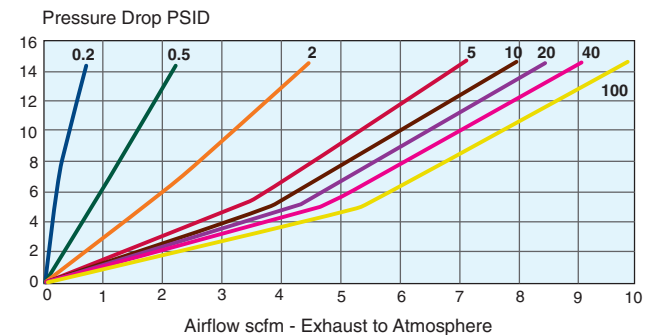
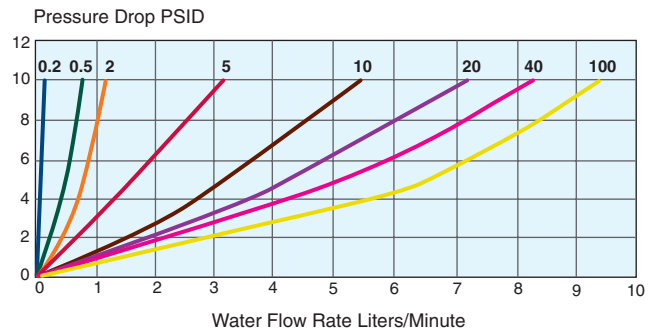

# Series 6400 - Filter/sparger pipe reducer mounted.

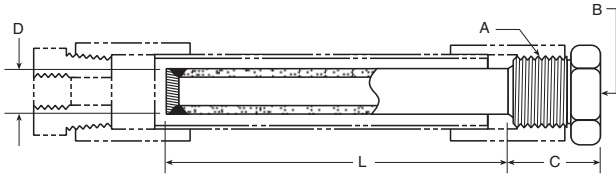

The Series 6400 filter/sparger is a versatile product featuring a Mott precision porous metal seamless tube, and may be used for gas/liquid contacting as well as filtration applications. It is designed primarily for users who want to fabricate their own inline filters, sampling devices or spargers.

**Materials of construction:** 316L stainless steel porous media, 316 stainless steel hardware.  
Filter element 100% leak tested to bubble point.

## Filter options.

**Series No.** - 6400 (filter/sparger)

### Dimensions

(D) - Diameter	(A) - Male	(B) - Female Pipe Size	(C)
- 3/8"	- 1/4"	- 1/8"	- 1.06"
- 3/8"	- 1/2"	- 1/8"	- 1.08"
- 1/2"	- 1/2"	- 1/4"	- 1.08"
- 1/2"	- 3/4"	- 1/4"	- 1.08"
- 3/4"	- 3/4"	- 1/2"	- 1.63"
- 3/4"	- 1"	- 1/2"	- 1.37"
- 1"	- 1"	- 3/4"	- 1.85"
- 1"	- 1 1/2"	- 3/4"	- 1.25"

**Lengths** 6", 12", 18", 24", 36"

**Media Grades** 0.5, 2, 5, 10, 20, 40

Note: For other sizes, NPT combinations, media grades or materials – consult factory.

## Filter area.

3/8"  $\varnothing$  element: 1.1 in<sup>2</sup> per inch of porous length  
 1/2"  $\varnothing$  element: 1.57 in<sup>2</sup> per inch of porous length  
 3/4"  $\varnothing$  element: 2.35 in<sup>2</sup> per inch of porous length  
 1"  $\varnothing$  element: 3.14 in<sup>2</sup> per inch of porous length

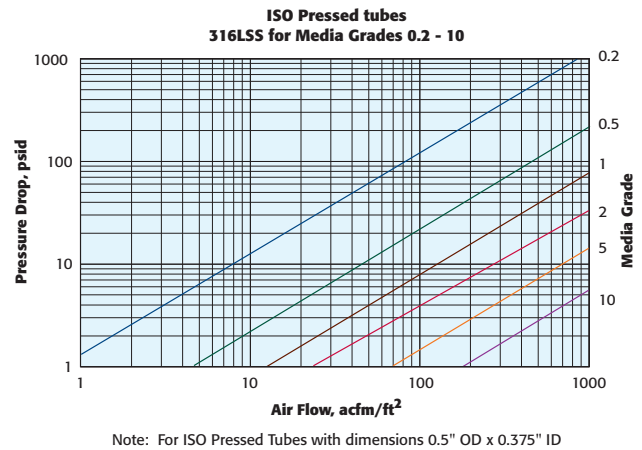

# Series 6500 – Pump inlet filters.

The Series 6500 features Mott precision porous metal cups and hardware of 316L stainless steel or titanium. They can be used as samplers and spargers in a wide range of applications.



## 6500.

Mott 6500 filters are easily adapted to flexible tubing or compression fittings. Standard filter dimensions are noted below.

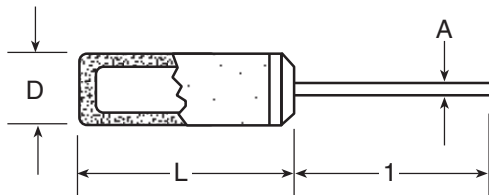

<b>Series No.</b>	- 6500 Filter		
<b>Dimensions</b>	(D)	(A)	(L)
	- Porous Diameter	- Tube Diameter	- Porous Length
	- 1/4"	- 1/16"	1"
	- 1/4"	- 1/8"	1"
	- 3/8"	- 1/16"	1"
	- 3/8"	- 1/8"	1"
	- 1/2"	- 1/16"	1"
	- 1/2"	- 1/8"	1"
	- 11/16"	- 1/16"	27/32"
	- 11/16"	- 1/8"	27/32"

**Media Grades** 0.5, 2, 5, 10, 20, 40, 100

## 6510.

Mott 6510 filters are complete with a compression-type tube connection. Standard filter dimensions are noted below.

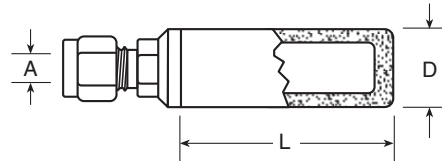

<b>Series No.</b>	- 6510 Filter		
<b>Dimensions</b>	(D)	(A)	(L)
	- Porous Diameter	- Tube Diameter	- Porous Length
	- 1/2"	- 1/16"	1"
	- 1/2"	- 1/8"	1"
	- 11/16"	- 1/16"	27/32"
	- 11/16"	- 1/8"	27/32"
	- 13/16"	- 1/16"	1 1/16"
	- 13/16"	- 1/8"	1 1/16"
<b>Media Grades</b>	0.5, 2, 5, 10, 20, 40, 100		

## 6515-1/8.

For use with 1/8" Teflon® tubing, Mott 6515 filters are threaded for a self-tapping positive grip connection, eliminating costly tube fittings. Standard filter dimensions are noted below.

## 6515T-1/8.

All titanium construction.

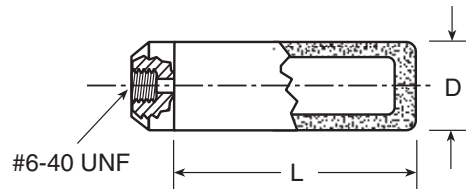

<b>Series No.</b>	- 6515 and 6515T Filter		
<b>Dimensions</b>	(D)	(Ref)	(L)
	- Porous Diameter	- Tube Diameter	- Porous Length
	- 3/8"	- 1/8"	5/8"
	- 1/2"	- 1/8"	3/4"
<b>Media Grades</b>	0.5, 2, 5, 10, 20, 40, 100		

**Media Grades** 0.5, 2, 5, 10, 20, 40, 100

Note: For other lengths, media grades or materials – consult factory.



# Series 6610 – Line filter elements.

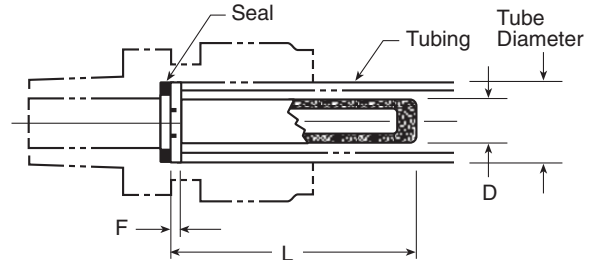

Series 6610 line filters are designed for line mounting in tubing with compression-type fittings. They are ideal for filtering liquids and gases to protect sensitive instruments.

Mott Series 6610 line filters are offered for three tube sizes, in a variety of media grades.

Standard materials are 316L stainless steel porous media and 316 stainless steel flange.

To assure a leak-tight seal in the assembly, o-ring seal should be used as noted above.

## Standard filter availability.

<b>Series No.</b>	- 6610 Filter		
<b>Dimensions</b>	(D)	(L)	(F)
	- Porous Diameter	- Porous Length	- Flange Thickness
	- 0.170"	- 0.64"	- 3/64"
	- 0.250"	- 1.00"	- 3/32"
	- 0.317"	- 1.463"	- 1/8"

**Media Grades** 0.5, 2, 5, 10, 20, 40

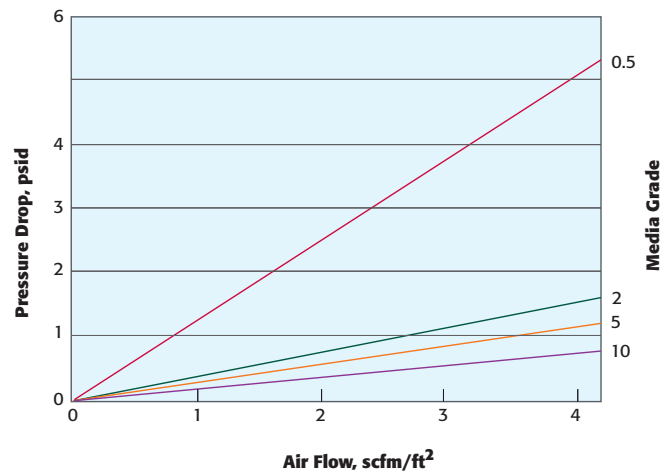

## Optional O-ring seal.

**Series No. 2-006** (Element dia. 0.170") - **Select seal material**

**Series No. 2-010** (Element dia. 0.250") - **Select seal material**

**Series No. 2-012** (Element dia. 0.317") - **Select seal material**

**Seal Materials**

- B (Buna N)
- N (Neoprene)
- T (Teflon®)
- V (Viton)

Note: For other lengths, media grades, or materials – consult factory.



# Mott sampling filter.

## Series 8501 – threaded assembly.

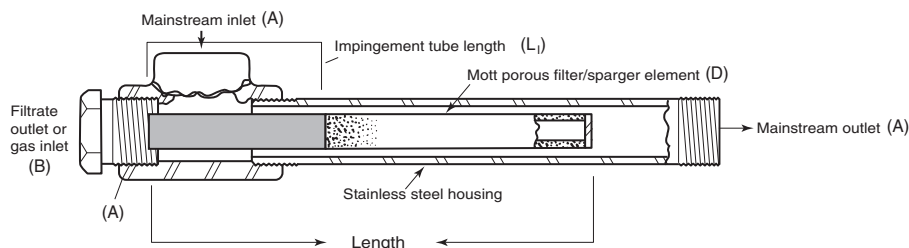

### Operating principle as sampling filter.

The gas or liquid to be sampled is introduced at the mainstream inlet and accelerates as it passes the filter, due to the reduced flow passage. This increased velocity puts the filter into an inertial mode. Plugging is minimized, since particulate matter in the mainstream is directed parallel to the filter tube rather than incident to the porous media.

### Filter applications.

- Particulate-free sampling.
- Liquid analysis.

### Advantages.

- High differential pressure capability.
- Wide range of porosities.
- Self-cleaning for long on-stream life.
- Simple, all stainless-steel assembly.
- Uniform permeability.

### Operating principle as sparger or gas/liquid contactor.

Liquid is introduced at the mainstream inlet and accelerates around the porous element. Gas is injected at left, through the porous tube, creating extremely fine bubbles. As these bubbles emerge from the porous tube, they are continuously sheared by the liquid – further reducing their size and increasing the gas/liquid interface. Bubble size can be varied by adjusting velocity. Higher velocities result in higher shear rates and finer bubble size.

### Sparger applications.

- Carbonation, aeration, hydrogenation.
- Injection of air, oxygen, hydrogen or other gases for gas/liquid reactions.

### Advantages.

- Uniform permeability for consistent bubble size.
- Dynamic reduction of bubble size for maximum efficiency.
- High efficiency from bubble shear reduces sparger size required.

### Standard filter availability.

**Series No.** - 8501 filter

### Fitting Size

(A)	(B)	(D)	(L <sub>1</sub> )
- Mainstream NPT	- Filtrate Outlet Gas Inlet NPT	- Porous Diameter	- Impingement Tube Length
- 1/2"	- 1/8"	- 3/8"	- 2"
- 3/4"	- 1/4"	- 1/2"	- 2 1/4"
- 1"	- 1/2"	- 3/4"	- 2 1/2"
- 1 1/2"	- 3/4"	- 1"	- 3 1/2"

**Lengths** 6", 12", 18", 24", 36"

**Media Grades** 0.5, 2, 5, 10, 20, 40

### Spare parts options: replacement elements.

**Elements** Series No. 850

### Fitting Size

(A)	(B)	(D)	(L <sub>1</sub> )
- Male NPT	- Female NPT	- Porous Diameter	- Impingement Tube Length
- 1/2"	- 1/8"	- 3/8"	- 2"
- 3/4"	- 1/4"	- 1/2"	- 2 1/4"
- 1"	- 1/2"	- 3/4"	- 2 1/2"
- 1 1/2"	- 3/4"	- 1"	- 3 1/2"

**Lengths** 6", 12", 18", 24", 36"

**Media Grades** 0.5, 2, 5, 10, 20, 40

# Porous metal filters for chromatography.



Mott pump inlet filters are used for the protection of HPLC pump inlet check valves, and can also be used as a sinker to hold pump inlet tubing at the bottom of the solvent supply. The offering includes three types and are offered in 316L SS or titanium depending on the strength and corrosion resistance required. For other materials, consult factory.

**Model 6500** – Easily adaptable to flexible tubing or compression fittings.

**Model 6510** – Complete with a compression-type tube connection.

**Model 6515 and 6515T** – For use with 1/8" *Teflon*<sup>®</sup> tubing, these filters are threaded for a self-tapping, positive grip connection.

Mott also offers three types of frits or porous metal discs for use in the HPLC column. This includes the UniDense, Concave and Dual-Density Frit designs.

**UniDense Frits** – Used for uniform flow across entire frit surface.

**Dual-Density Frits** – Used to limit flow to the interior region of the frit, greatly reducing dead volume that can cause peak asymmetry.

**Concave Frits** – Used to enhance flow uniformity, eliminating the need for a flow distribution plate.

Other product offerings Mott supplies to this industry include:

- Flow restrictors
- Standard encapsulated flow restrictors
- Filter cups (316L SS and titanium)
- Duplex frits
- Welded assemblies

## UniDense Frit in an HPLC Column

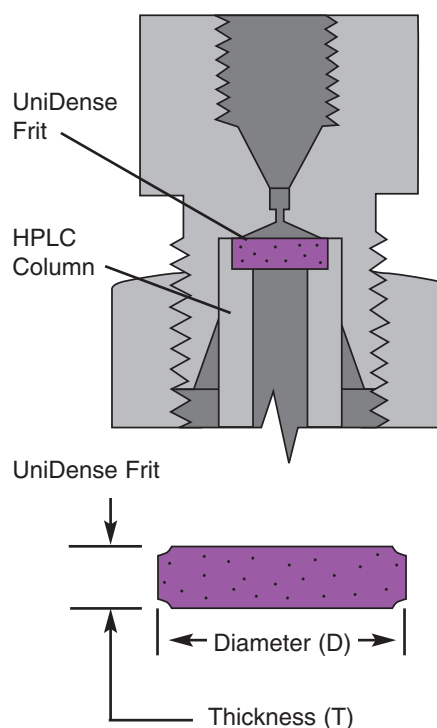

## Standard tolerances for media grades 0.2 to 10 in 316L SS

Diameter (in.)	Diameter D (in.)	Thickness T (in.)
0 - .187	±.002	±.005
.188 - .375	±.003	±.005
.376 - .500	±.005	±.007
.501 - .750	±.007	±.007
.751 - 1.000	±.008	±.009
1.001 - 2.000	±.010	±.010
2.001 - Up	Consult Factory	

Closer tolerances available on special order.

### Dual Density Frit in an HPLC Column

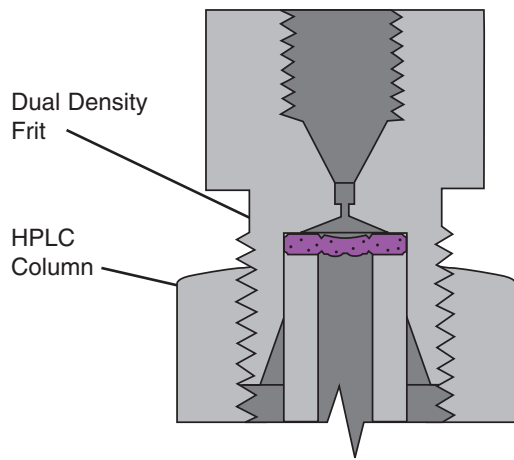

Model DD

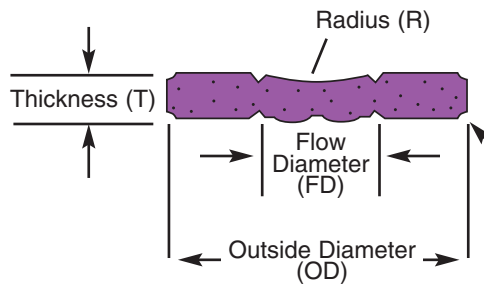

### Concave Frit in an HPLC Column

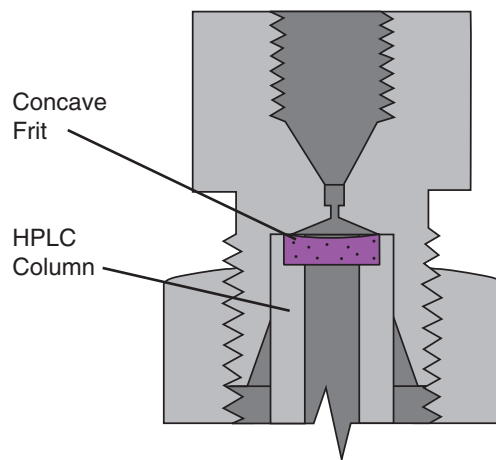

Concave Frit

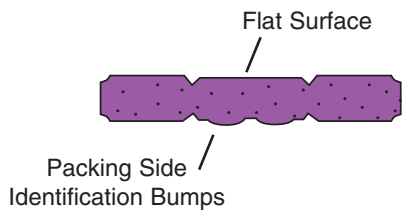
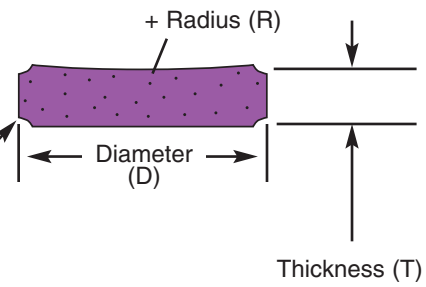

Outside Diameter OD (in.)	Flow Diameter FD (in.)	Radius R (in.)	Thickness T (in.)
.247	.077	.070	.035
.247	.077	FLAT	.035
.247	.102	.146	.035
.247	.102	FLAT	.035
.247	.170	.482	.035
.247	.170	FLAT	.035

Diameter D (in.)	Thickness T (in.)	Radius R (in.)
.212	.020	.886
.247	.035	.938
.312	.046	1.581

Established in 1959, Mott Corporation coordinates engineering, sales, service and manufacturing from two adjacent facilities totalling 90,000 square feet. Mott's skilled workforce, along with strategically located overseas affiliates, services thousands of customers all over the world, in virtually every major segment of industry.

**Need a product? Need advice?**

Call us either way. Whether you need a stock solution, a customized design, or simply guidance, we welcome your call. Contact the experts at Mott Corporation today.

**mott corporation**

84 Spring Lane, Farmington, CT 06032-3159  
www.mottcorp.com, email: quest@mottcorp.com  
860-747-6333 Fax 860-747-6739



ISO 9001:2008 CERTIFIED

PMINST Rev 2 10/08 5C